

Blaster™



MARINE PRODUCT DATA SHEET

OEM: 3901-2204
AFTERMARKET: 3901-2214

Perfect for tough washdown applications, such as fish box, scaling, and anchor chain cleaning, these rugged self-priming pump deliver high lift, can run dry without damage, and won't overheat with extended use. Pump is ignition protected and switch is sealed against water damage.

TYPICAL APPLICATIONS

Marine fresh or salt water wash down installations. Other uses may include 12 VDC pressurized water systems. This pump may be used for general water transfer. For other applications, contact SHURflo.

PUMP

Type: 3 Chamber Diaphragm
Ports: 1/2"-14 NPSM-Male.
Liquid: 130 °F [54 °C] Max
Prime: 6 feet [1.82 M]
Inlet PSI: 30 PSI [2.1 Bar] Max
Run Dry: Yes

ELECTRICAL

Motor: 12VDC Permanent Magnet, Intermittent Duty
Protection: Thermal Overload, Automatic Restart
Leads: 16 AWG, 16" [40 cm] Red +, 13" [33 cm] Black -
Fuse: 10 Amp Recommended
Control: Adjustable Switch. Shut-Off 45 PSI [3.1 Bar] ± 5 PSI [0.4 Bar]
Restart 25 PSI [1.7 Bar] ± 5 PSI [0.4 Bar]

MATERIALS

Housing: Polypro
Valves: EPDM
Diaphragm: Santoprene
Hardware: Stainless Steel

APPROVALS

Ignition Protected, CE, ISO 8846

WARRANTY

3 Year Limited Warranty
See SB-1041 & SB-1050 For Full Warranty Details

SHIPPING

Net Weight (Boxed): 4.8 Lb [2.2 Kg] each
Carton Weight: 58 Lb [26.3 Kg]
Carton Size: 27"L x 18"W x 11"H
[60.9cm x 45.7cm x 27.9cm]

RELATED DOCUMENTS

Catalog: MS-030-140
Installation Manual: 911-732
Maintenance: 911-732
Applications Spec Guide: MS-020-005
Warranty: SB-1050

Replacement Kits

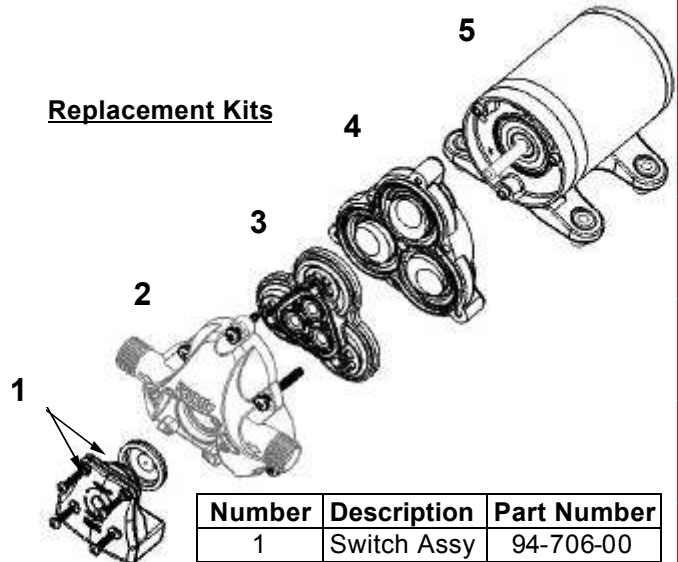

Number	Description	Part Number
1	Switch Assy	94-706-00
2	Upper Hsg	94-706-01
3	Valve Assy	94-706-02
4	Drive Assy	94-706-06
5	Motor	11-173-12



PERFORMANCE @ 12V DC

PRESSURE		FLOW		CURRENT
BAR	PSI	GPM	LPM	AMPS
0.0	0	3.80	14.3	4.15
0.7	10	2.54	9.61	4.94
1.4	20	1.83	6.92	5.24
2.1	30	1.34	5.07	5.57
2.8	40	0.95	3.59	5.74

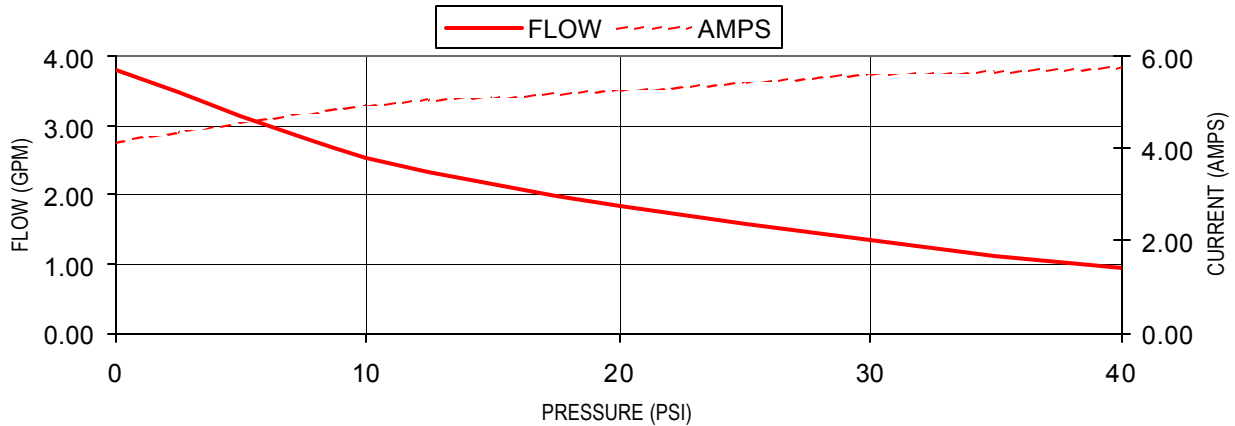

DIMENSIONS [mm]

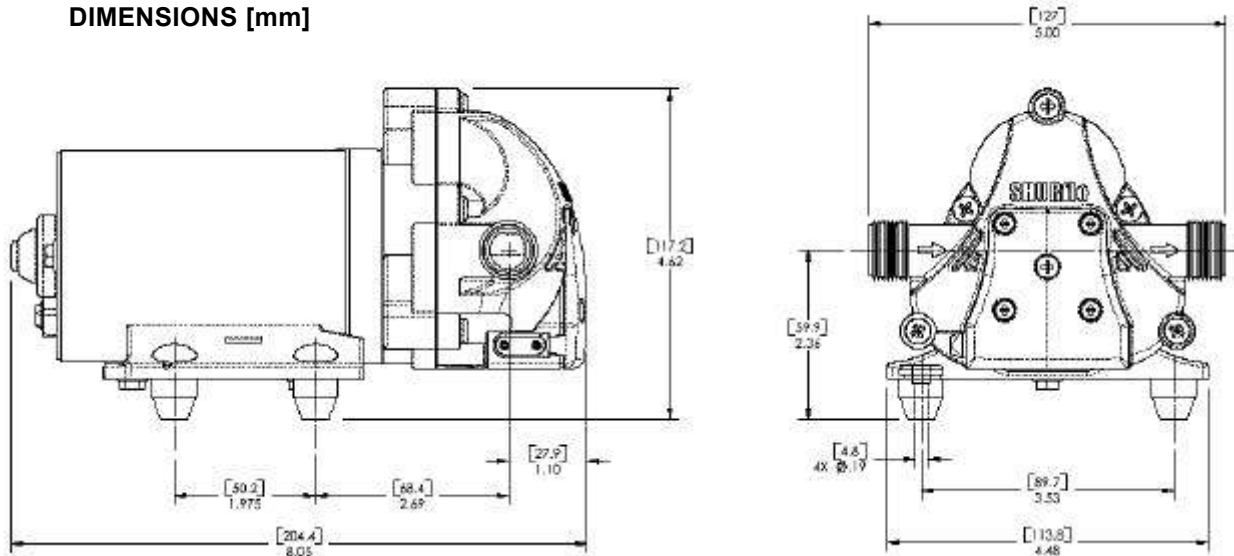

*ISO Registered Facility *SHURflo reserves the right to update specifications, prices, or make substitutions.*

SHURflo *
 5900A Katella Ave.
 Cypress, Ca. 90630
 (800) 854-3218 (562) 795-5200
 FAX (562) 795-7554
 Shipping/UPS: 5900C Katella Ave.
 Cypress, Ca. 90630

SHURflo East
 52748 Park Six Court
 Elkhart, IN 46514-5427
 (800) 762-809 (574) 262-0478
 FAX (574) 264-2169
 Http://www.shurflo.com
 © 2001

SHURflo Ltd. *
 Unit 5 Sterling Park
 Gatwick Road, Crawley
 West Sussex, RH10 2QT
 United Kingdom
 +44 1293 424000
 FAX +44 1293 421880

