

MARINE PRODUCT DATA SHEET

OEM: 1700-000-030 (500 GPH)
AFTERMARKET: 1700-001-030 (500 GPH)

APPLICATION

12V DC Bait/Livewell tanks water circulation

PUMP

Type: Centrifugal Pump, Magnetic Drive
Outlet Port: 3/4" Barb
Inlet Port: 3/4" NPT-M
Wash-Down Port: 1/2" NPT-F
Liquid: 130 °F [54 °C] Max
Prime: Flooded Inlet
Inlet PSI: 30 PSI [2.1 Bar] Max
Run Dry: Yes

ELECTRICAL

Motor: 12VDC Permanent Magnet,
Continuous Duty
Protection: Need External Fuse (Not supplied)
Leads: 6 ft [1.8M] Tinned, Twisted Jacketed Cable
Fuse: 2 Amp Recommended
Control: No Control

MATERIALS

Housing: High Strength Nylon
Impeller: Acetal
Hardware: Stainless Steel

APPROVALS

Ignition Protected 8846, CE

WARRANTY

3 Year Limited Warranty. Contact SHURflo for details

SHIPPING

Net Weight (Boxed): 2.5 Lb [1.1 Kg] each
Approx. Lbs./Ctn. 14 Lb [6.3 Kg]
Pumps in Carton: 6
Carton Size: 16"L x 11"W x 11" H
[41cm x 28 cm x 28 cm]

RELATED DOCUMENTS

Catalog: MS-030-140
Installation Manual: 911-466
Applications Spec Guide: MS-020-005



The Bait Sentry Livewell Pumps are designed for easy installation and trouble-free operation. Magnetic Drive technology eliminates unnecessary failures. Motors keep running after ingesting debris or even when running dry. Patented anti-airlock feature allows the pump to clear trapped air in rough water or when boat is anchored. Includes dual port for easy washdown pump connection.

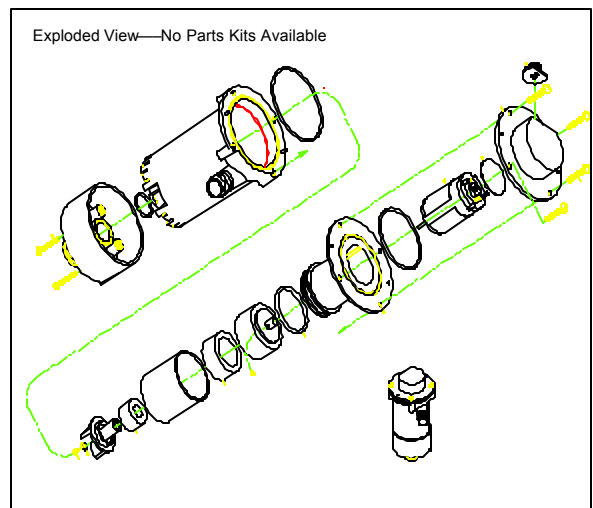

TYPICAL PERFORMANCE

PRESSURE		FLOW		CURRENT
METERS	FT OF HEAD	GPH	LPH	AMPS
0.0	0	500	1892	1.4
0.9	3	289	1093	1.3
1.5	5	0	0	1.1

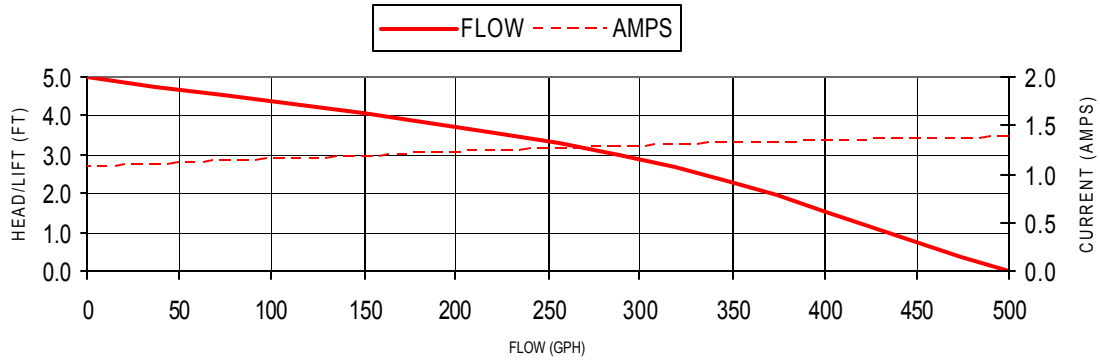

DIMENSIONS [mm]

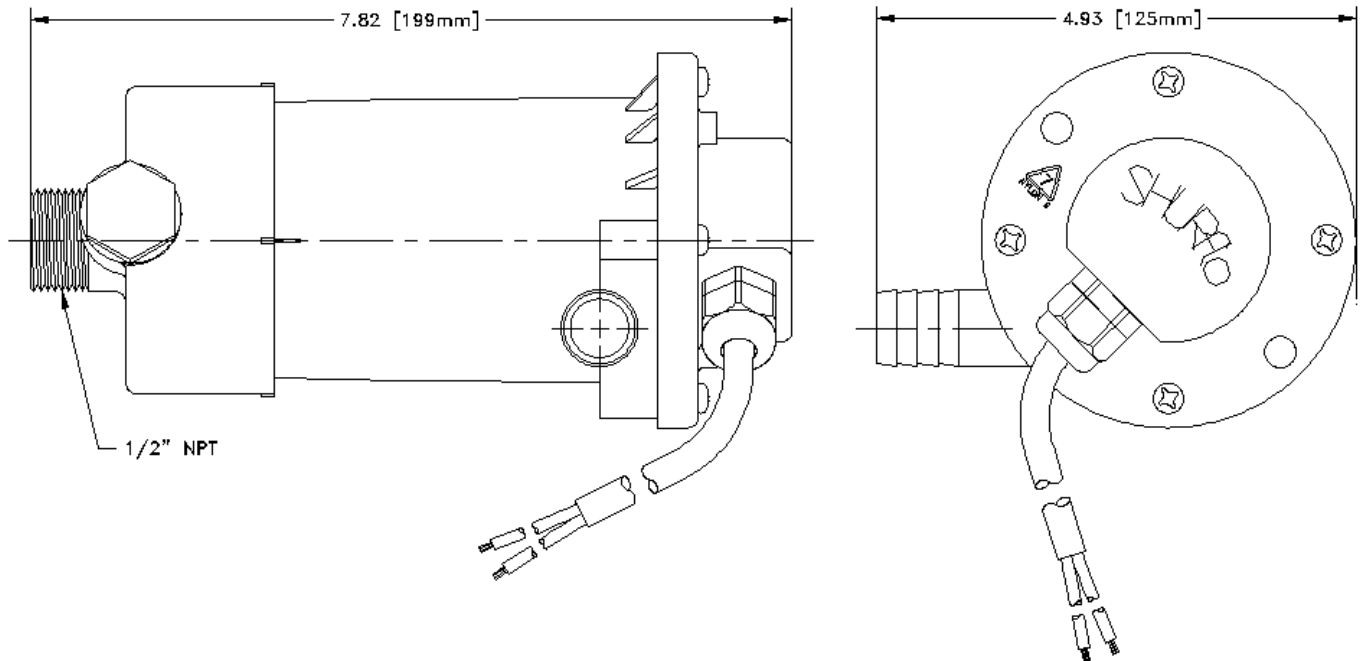

Visit our Web Site at <http://www.shurflo.com>
 Shurflo reserves the right to update specifications,
 change prices, or make substitutions without notice.

SHURflo
 5900 Katella Avenue
 Cypress, CA 90630
 Phone (562) 795-5200
 Toll Free (800) 854-3218
 Fax (562) 795-7564

SHURflo East
 52748 Park Six Court
 Elkhart, IN 46514-5427
 Phone (562) 795-5200
 Toll Free (800) 854-3218
 Fax (574) 264-2169

SHURflo Europe, Middle East, Africa
 Pentair Water Belgium bvba
 Industriepark Wolfstee, Toekomstlaan 30
 B-2200 Herentals, Belgium
 Phone +32-14-283500
 Fax +32-14-283505



Pentair Water

FLOW TECHNOLOGIES GROUP
 5900 Katella Ave, Cypress, CA 90630
 Phone (800) 854-3218 • (562) 795-5200 • Fax (562) 795-7564
www.shurflo.com